

Data sheet | Item number: 2020-215

2-conductor female connector; 1.5 mm²; 15-pole

2020-215

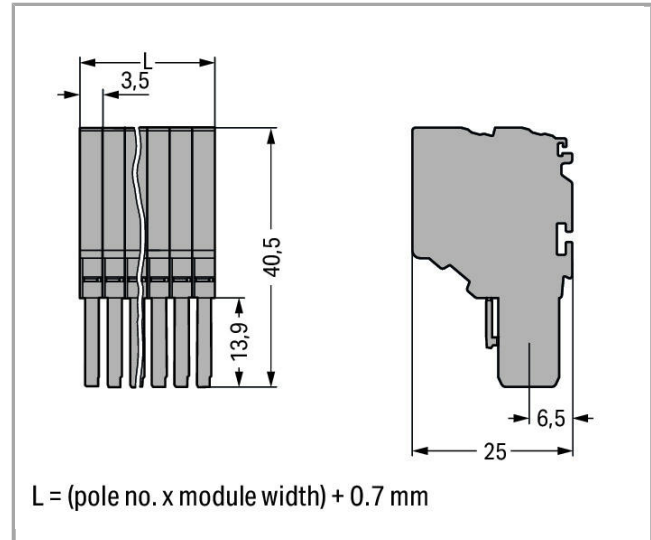
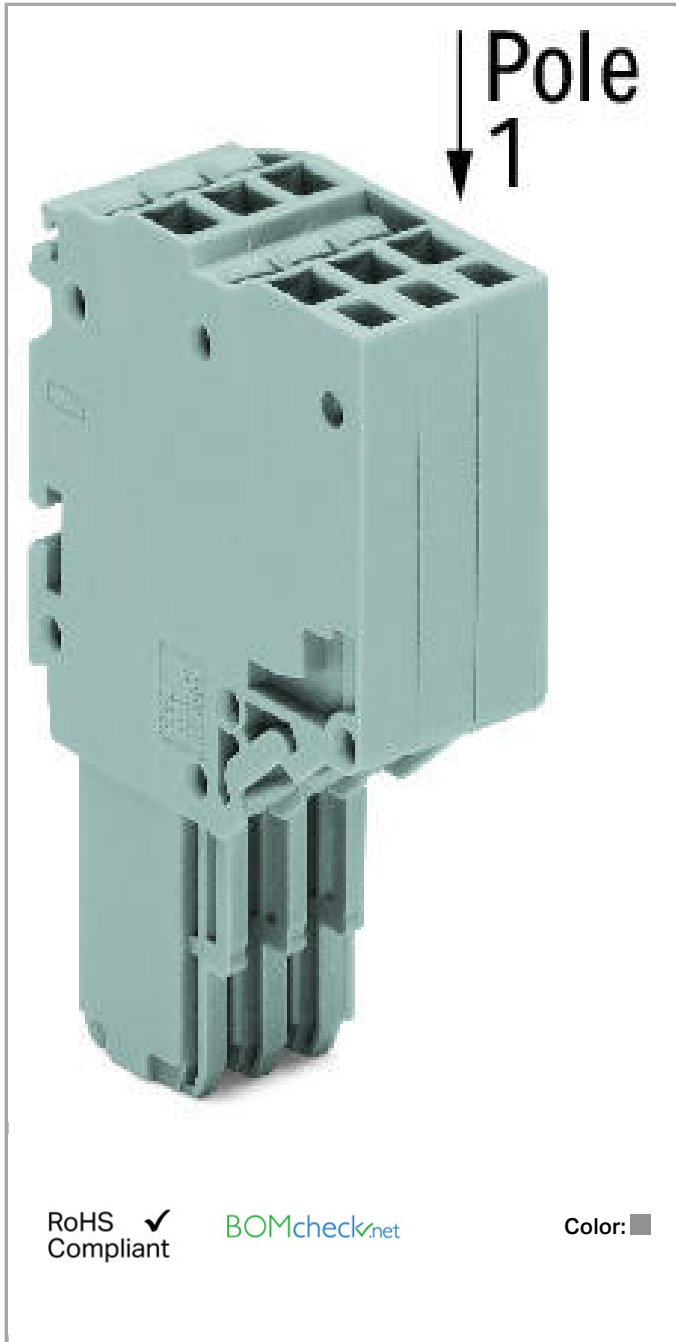

Item description

According to EN 61984, pluggable connectors without current interrupting capacity shall not be mated and unmated when live or under load.

Data

Electrical data

Ratings per IEC/EN 60664-1

Rated voltage (III / 3)	500 V
Rated impulse voltage (III / 3)	6 kV
Rated current	13.5 A

Approvals per UL 1059

Rated voltage UL (Use Group B)	300 V
Rated current UL (Use Group B)	15 A
Rated voltage UL (Use Group C)	300 V
Rated current UL (Use Group C)	15 A
Rated voltage UL (Use Group D)	300 V
Rated current UL (Use Group D)	15 A

Approvals per CSA

Rated voltage CSA (Use Group B)	300 V
Rated current CSA (Use Group B)	10 A
Rated voltage CSA (Use Group C)	300 V
Rated current CSA (Use Group C)	10 A

Connection data

Connection technology	Push-in CAGE CLAMP®
Actuation type	Open Tool Slot Push-in
Connectable conductor materials	Copper
Nominal cross section	1 mm ²
Solid conductor	0.14 ... 1.5 mm ² / 24 ... 16 AWG
Solid conductor, push-in termination	0.5 ... 1.5 mm ² / 20 ... 16 AWG
Fine-stranded conductor	0.14 ... 1.5 mm ² / 24 ... 16 AWG
Strip length	9 ... 11 mm / 0.35 ... 0.43 inch
Note (conductor cross-section)	Depending on the conductor characteristic, a conductor with a smaller cross section can also be inserted via push-in termination.
No. of poles	15
Total number of connection points	30
Total number of potentials	15
Type of wiring	Front-entry wiring

Geometrical Data

Width	53.2 mm / 2.094 inch
Height	40.5 mm / 1.594 inch
Depth	25 mm / 0.984 inch
Module width	3.5 mm / 0.138 inch

Mechanical data

Marking level	Side marking
---------------	--------------

Plug connection

Contact type (pluggable connector)	Female connector/socket
Connector connection type	for conductors

Material Data



Color	gray
Insulating material	Polyamide 66 (PA 66)
Fire load	0.676 MJ
Weight	41.06 g

Commercial data





Product Group	18 (X-COM-System)
Country of origin	DE
GTIN	4045454855376
Customs Tariff No.	85366990990

Approvals / Certificates



Country specific Approvals

Logo	Approval	Additional Approval Text	Certificate name
	CCA DEKRA Certification B.V.	EN 60947	NTR NL 7617
	CSA DEKRA Certification B.V.	C22.2 No. 158	2516073
	CSA DEKRA Certification B.V.	C22.2 No. 158	2516073



Ship Approvals

















Logo	Approval	Additional Approval Text	Certificate name
	ABS American Bureau of Shipping	EN 60947	14- HG1293677- PDA
	BV Bureau Veritas S.A.	EN 60947	38586/A0 BV
	DNV GL Det Norske Veritas, Germanischer Lloyd	-	TAE00001V2
	LR Lloyds Register	EN 60947	91/20112 (E9)





UL-Approvals

Logo	Approval	Additional Approval Text	Certificate name
	UL UL International Germany GmbH	UL 1059	E45172
	UL Underwriters Laboratories Inc.	UL 1059	E45172

Compatible products

ferrule			
	Item no.: 216-241 Ferrule; Sleeve for 0.5 mm ² / 20 AWG; insulated; electro-tin plated; electrolytic copper; gastight crimped; acc. to DIN 46228, Part 4/09.90		216-241
	Item no.: 216-242 Ferrule; Sleeve for 0.75 mm ² / 18 AWG; insulated; electro-tin plated; electrolytic copper; gastight crimped; acc. to DIN 46228, Part 4/09.90		216-242

	<p>Item no.: 216-243 Ferrule; Sleeve for 1 mm² / AWG 18; insulated; electro-tin plated; electrolytic copper; gastight crimped; acc. to DIN 46228, Part 4/09.90</p>	216-243
Strain relief plate		
	<p>Item no.: 734-326 Strain relief plate</p>	734-326
	<p>Item no.: 734-430 Strain relief plate</p>	734-430
	<p>Item no.: 734-431 Strain relief plate</p>	734-431
Locking lever		
	<p>Item no.: 2022-151 Locking lever; can be snapped on 1-conductor female plugs; 2 poles and more</p>	2022-151
	<p>Item no.: 2022-152 Locking lever; can be snapped on 1-conductor female plugs; 2 poles and more</p>	2022-152
tools		
	<p>Item no.: 210-647 Operating tool with partially insulated shaft; Blade (2.5 x 0.4) mm; short</p>	210-647
	<p>Item no.: 210-648 Operating tool with partially insulated shaft; Blade (2.5 x 0.4) mm; short; angled</p>	210-648
	<p>Item no.: 210-719 Operating tool with partially insulated shaft; Type 1, blade (2.5 x 0.4) mm</p>	210-719
Protective Warning Marker		
	<p>Item no.: 2000-115 Protective warning marker; with high-voltage symbol, black; for 5 terminal blocks</p>	2000-115
Marking accessories		
	<p>Item no.: 2009-113 WMB-Inline; for Smart Printer; on reel; plain; snap-on type</p>	2009-113
	<p>Item no.: 2009-113/000-002 WMB-Inline; for Smart Printer; on reel; plain; snap-on type</p>	2009-113 /UUU-UUZ
	<p>Item no.: 2009-113/000-005 WMB-Inline; for Smart Printer; on reel; plain; snap-on type</p>	2009-113 /UUU-UU5
	<p>Item no.: 2009-113/000-006 WMB-Inline; for Smart Printer; on reel; plain; snap-on type</p>	2009-113 /UUU-UU6
	<p>Item no.: 2009-113/000-007 WMB-Inline; for Smart Printer; on reel; plain; snap-on type</p>	2009-113 /UUU-UU7
	<p>Item no.: 2009-113/000-012 WMB-Inline; for Smart Printer; on reel; plain; snap-on type</p>	2009-113 /UUU-U1Z

	<p>Item no.: 2009-113/000-017 WMB-Inline; for Smart Printer; on reel; plain; snap-on type</p>	/000-017	2009-113
	<p>Item no.: 2009-113/000-023 WMB-Inline; for Smart Printer; on reel; plain; snap-on type</p>	/000-023	2009-113
	<p>Item no.: 2009-113/000-024 WMB-Inline; for Smart Printer; on reel; plain; snap-on type</p>	/000-024	2009-113
	<p>Item no.: 793-3501 WMB marking card; as card; plain; snap-on type</p>		793-3501

Downloads

Documentation

Bid Text

2020-215	docx 15.5 kB	Download
----------	-----------------	----------

Additional Information

	pdf 2.1 MB	Download
--	---------------	----------

CAD/CAE - Smart Data

CAD data

3D Download 2020-215	URL	Download
----------------------	-----	----------

Product family

X-COM S-Mini
[Show all products from the family](#)

Subject to changes.